

RPower VDS12-7,0 (12V 7Ah AGM Battery)

VdS No. G117043

EAN: 4260349822626

Floating Life at 20°C designed for up to 6 years

Dimensions

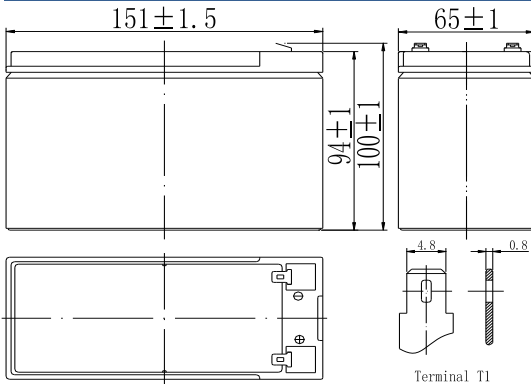

Specifications

Nominal Voltage		12V
Capacity (20hr@25°C)		7Ah
Dimensions (±2mm)	Length	151mm (5.94inch)
	Width	65mm (2.56inch)
	Height	94mm (3.70inch)
	Total Height	100mm (3.94inch)
Approx. Weight		2.38kg (5.25lbs)
Maximum charging current		2.10A
Maximum discharge current		105A (5sec.)
Internal resistance		Approx. 25mΩ
Capacity affected by temperature (20hr)	40°C	102%
	25°C	100%
	0°C	85%
	-15°C	65%
Self-discharge (25°C)	3 month	Remaining Capacity: 91%
	6 month	Remaining Capacity: 82%
	12 month	Remaining Capacity: 65%
Nominal operating temperature		25°C ±3°C (77°F±5°F)
Operating temperature range		-20°C~50°C (-4°F~122°F)
Float charging voltage (25°C)		13.65 to 13.80V
Cyclic charging voltage (25°C)		14.40 to 15.00V
Terminal material		Copper

The Relationship for Charging Voltage and Temperature

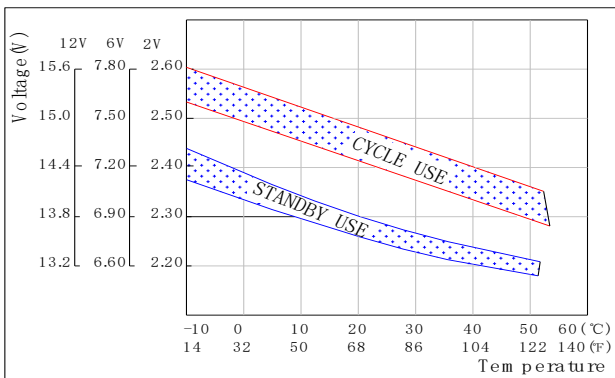

Charging Characteristics (25°C)

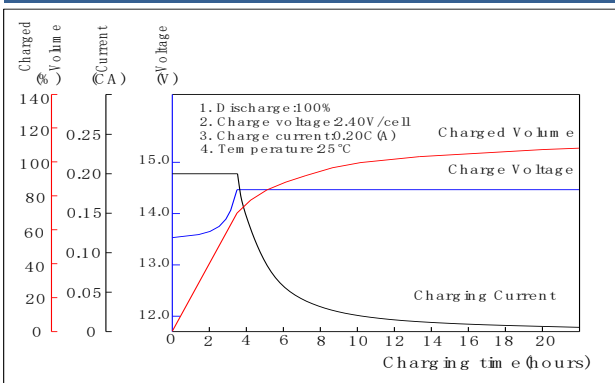

Discharge Characteristics (25°C)

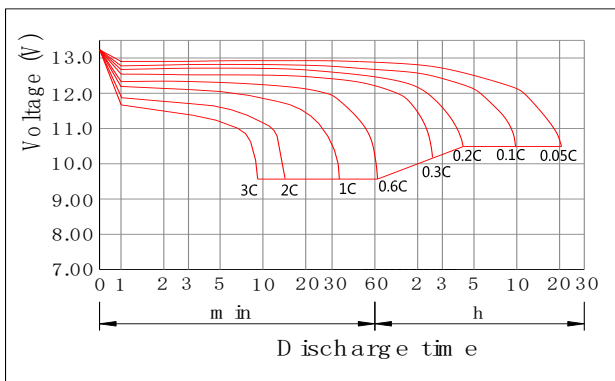

Constant Current Discharge Characteristics (Ampere / Battery, 25°C)

FV / TIME	5min	10min	15min	30min	1h	3h	5h	10h	20h
10.80V	25,00	16,20	13,00	7,40	4,37	1,76	1,20	0,70	0,35
10.20V	26,60	17,20	13,70	7,79	4,61	1,80	1,22	0,71	0,36
9.60V	28,00	18,10	14,30	8,12	4,80	1,83	1,24	0,71	0,37

Constant Power Discharge Characteristics (Watt / Battery, 25°C)

FV / TIME	5min	10min	15min	30min	1h	3h	5h	10h	20h
10.80V	279,00	183,00	148,00	84,80	50,70	21,00	14,30	8,46	4,38
10.20V	297,00	194,00	156,00	89,00	53,00	21,40	14,60	8,50	4,41
9.60V	313,00	204,00	162,00	93,00	55,50	21,70	14,80	8,57	4,45